

HAND RAIL Profiles

Builders Guide to Custom Moulding & Millwork 1.0

Sec. 11

Profiles at a glance in order by Width.

Profile No.	H	x	W	Page
HA-2	1-7/8"	x	2-1/2"	1
HA-4	2-1/8"	x	2-3/4"	1
HA-7	2-5/8"	x	3"	1
HA-1	2-5/8"	x	3-1/2"	1
HA-5	2-1/2"	x	4"	1
HA-3	2-3/4"	x	4"	1
HA-8	1-3/4"	x	4-1/4"	2
HA-6	3-1/2"	x	4-7/8"	2

Request your own custom profile.

Call today!
1-847-869-8669

ASH-HA-2

2-1/2" - Width

1-7/8" - Height

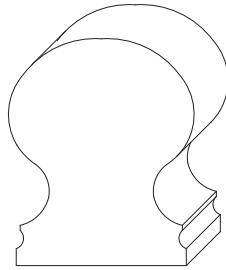

ASH-HA-4

2-3/4" - Width

2-1/8" - Height

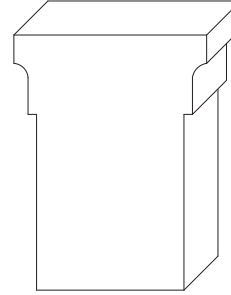

ASH-HA-7

3" - Width

2-5/8" - Height

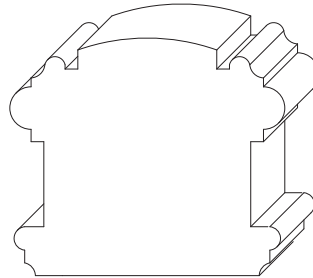

ASH-HA-1

3-1/2" - Width

2-5/8" - Height

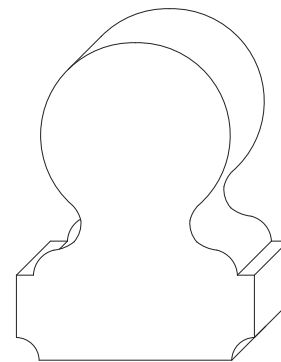

ASH-HA-5

4" - Width

2-1/2" - Height

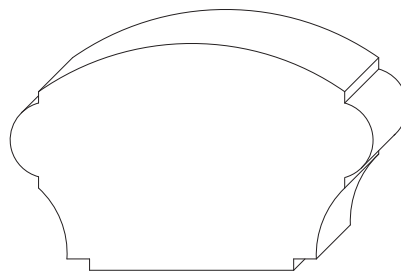

ASH-HA-3

4" - Width

2-3/4" - Height

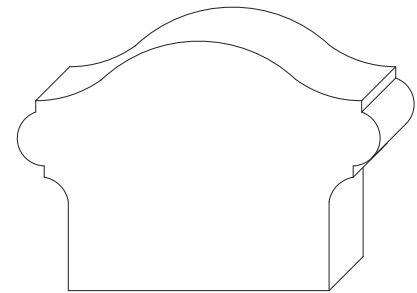

*Profile Heights, Widths and/or Widths may be modified.

Ashland Millwork
The finishing touch.™

2143 Ashland Avenue
Evanston, Illinois 60201

Tel: 1-847-869-8669 Fax: 1-847-869-8744

Email: sales@ashlandmillwork.com Web: www.ashlandmillwork.com

Job Name: _____

Architect/Builder: _____

Wood Species: _____ Qty: _____ LF.

Profile No.: _____

Sec. 11 - 1

Drawings are NOT actual size.
Scaled drawings to size available upon request.

HAND RAIL Profiles

Builders Guide to Custom Moulding & Millwork 1.0

Sec. 11

Profiles at a glance in order by Width.

Profile No.	H	x	W	Page
HA-2	1-7/8"	x	2-1/2"	1
HA-4	2-1/8"	x	2-3/4"	1
HA-7	2-5/8"	x	3"	1
HA-1	2-5/8"	x	3-1/2"	1
HA-5	2-1/2"	x	4"	1
HA-3	2-3/4"	x	4"	1
HA-8	1-3/4"	x	4-1/4"	2
HA-6	3-1/2"	x	4-7/8"	2

Request your own custom profile.

Call today!
1-847-869-8669

ASH-HA-8

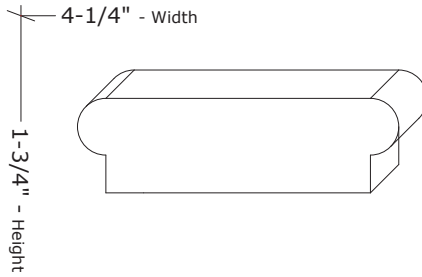

ASH-HA-6

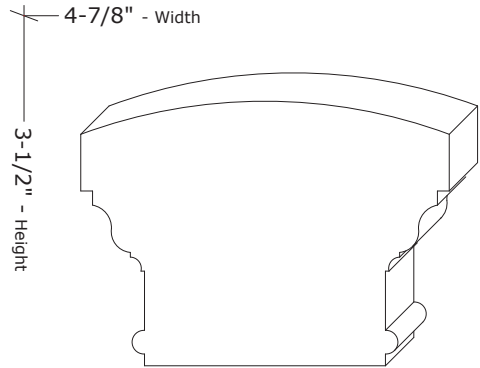

Drawings are **NOT** actual size.
Scaled drawings to size available upon request.

**Ashland
Millwork**
The finishing touch.™

2143 Ashland Avenue
Evanston, Illinois 60201
Tel: 1-847-869-8669 Fax: 1-847-869-8744
Email: sales@ashlandmillwork.com Web: www.ashlandmillwork.com

*Profile Heightes, Widths and/or Widths may be modified.

Job Name: _____
Architect/Builder: _____
Wood Species: _____ Qty: _____ LF.
Profile No.: _____

Sec. 11 - 2