

# BRICK MOULD Profiles

Builders Guide to Custom Moulding & Millwork 1.2

## Sec. 5

Profiles at a glance in order by Width.

Profile No.	Th (thickness)	x	W	Page
BR-8	11/16"	x	1-3/8"	1
BR-18	15/16"	x	1-1/2"	1
BR-24	1-1/2"	x	1-3/4"	1
BR-14	1-1/2"	x	1-13/16"	1
BR-1	1-1/2"	x	1-7/8"	1
BR-25	1-3/8"	x	1-15/16"	1
BR-28	1-9/16"	x	1-15/16"	2
BR-22	1-3/4"	x	1-15/16"	2
BR-15	1-3/16"	x	2"	2
BR-10	1-1/4"	x	2"	2
BR-9	1-3/4"	x	2"	2
BR-3	2"	x	2"	2
BR-17	1-1/16"	x	2-3/8"	3
BR-6	1-3/8"	x	2-1/2"	3
BR-16	1-11/16"	x	2-11/16"	3
BR-7	1-1/8"	x	2-3/4"	3
BR-2	1-11/16"	x	2-3/4"	3
BR-27	1-11/16"	x	3"	3
BR-13	1"	x	3-1/2"	4
BR-12	1-1/2"	x	3-1/2"	4
BR-19	1-7/8"	x	3-1/2"	4
BR-4	2"	x	3-1/2"	4
BR-20	1-3/4"	x	4-5/8"	4
BR-5	1-7/8"	x	5-3/8"	4
BR-11	1-1/2"	x	5-1/2"	5
BR-21	1-7/8"	x	5-1/2"	5

Request your own custom profile.

Call today!  
1-847-465-8101

### ASH-BR-17

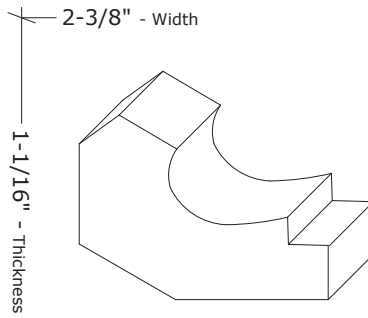

### ASH-BR-6

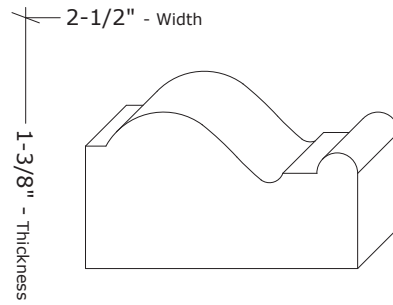

### ASH-BR-16

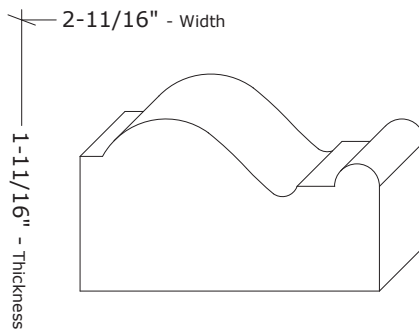

### ASH-BR-7

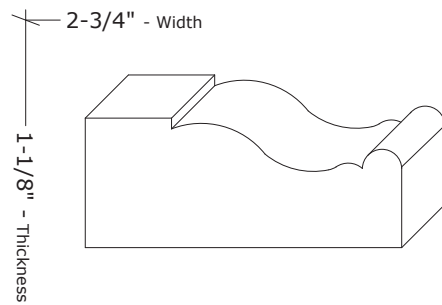

### ASH-BR-2

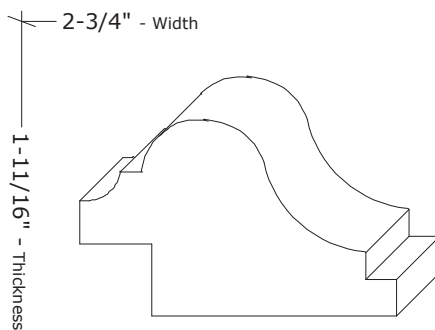

### ASH-BR-27

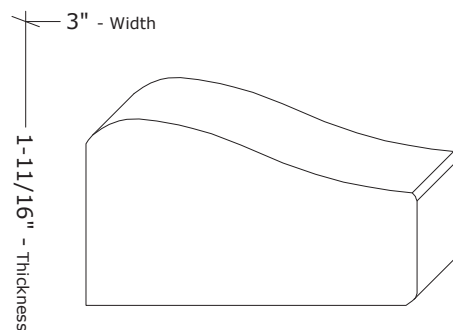

\*Profile Thicknesses, Widths and/or Widths may be modified.

**Ashland Millwork**

The finishing touch.™

5 Messner Drive  
Wheeling, IL 60090  
Tel: 1-847-465-8101 Fax: 1-847-465-8102  
Email: sales@ashlandmillwork.com Web: www.ashlandmillwork.com

Job Name: \_\_\_\_\_  
Architect/Builder: \_\_\_\_\_  
Wood Species: \_\_\_\_\_ Qty: \_\_\_\_\_ LF.  
Profile No.: \_\_\_\_\_

**Sec. 5 - 3**

Drawings are NOT actual size.  
Scaled drawings to size available upon request.