

# CASING Profiles

Builders Guide to Custom Moulding & Millwork 1.2

## Sec. 6

Profiles at a glance in order by Width.

Profile No.	Th (thickness)	x	W	Page
CA-163	3/4"	x	1-3/4"	1
CA-165	3/4"	x	2"	1
CA-232	3/4"	x	2"	1
CA-178	1"	x	2-1/8"	1
CA-115	5/8"	x	2-3/16"	1
CA-43	11/16"	x	2-1/4"	1
CA-55	11/16"	x	2-1/4"	1
CA-263	1-1/2"	x	2-1/4"	1
CA-71	3/4"	x	2-1/4"	2
CA-100	3/4"	x	2-1/4"	2
CA-74	3/4"	x	2-5/16"	2
CA-248	1-3/8"	x	2-3/8"	2
CA-28	9/16"	x	2-7/16"	2
CA-170	3/4"	x	2-7/16"	2
CA-233	3/4"	x	2-1/2"	2
CA-15	5/8"	x	2-1/2"	2
CA-148	5/8"	x	2-1/2"	3
CA-121	11/16"	x	2-1/2"	3
CA-118	3/4"	x	2-1/2"	3
CA-136	3/4"	x	2-1/2"	3
CA-138	3/4"	x	2-1/2"	3
CA-49	7/8"	x	2-1/2"	3
CA-154	7/8"	x	2-1/2"	3
CA-160	1"	x	2-1/2"	3
CA-252	15/16"	x	2-1/2"	4
CA-230	9/16"	x	2-9/16"	4
CA-182	5/8"	x	2-5/8"	4
CA-183	5/8"	x	2-5/8"	4
CA-145	1"	x	2-5/8"	4
CA-57	3/4"	x	2-3/4"	4
CA-58	3/4"	x	2-3/4"	4
CA-98	3/4"	x	2-3/4"	4
CA-153	3/4"	x	2-3/4"	5
CA-99	1"	x	2-3/4"	5
CA-88	1-3/8"	x	2-3/4"	5
CA-14	1/2"	x	2-13/16"	5
CA-81	1-3/8"	x	2-13/16"	5
CA-250	1-1/8"	x	2-7/8"	5
CA-109	5/8"	x	2-15/16"	5
CA-114	7/8"	x	2-15/16"	5
CA-130	5/8"	x	3"	6
CA-72	11/16"	x	3"	6
CA-34	3/4"	x	3"	6
CA-46	3/4"	x	3"	6
CA-48	3/4"	x	3"	6
CA-50	3/4"	x	3"	6
CA-82	3/4"	x	3"	6
CA-139	3/4"	x	3"	6
CA-169	3/4"	x	3"	7
CA-174	13/16"	x	3"	7
CA-30	7/8"	x	3"	7
CA-146	1"	x	3"	7
CA-53	1-1/8"	x	3"	7
CA-179	1-1/8"	x	3"	7
CA-131	1-1/4"	x	3"	7
CA-245	3/4"	x	3"	7
CA-258	5/8"	x	3"	8
CA-259	1-1/16"	x	3"	8
CA-262	1"	x	3"	8
CA-235	11/16"	x	3-1/16"	8
CA-236	9/16"	x	3-1/16"	8
CA-21	11/16"	x	3-1/16"	8
CA-152	3/4"	x	3-1/16"	8
CA-229	5/8"	x	3-1/8"	8
CA-22	5/8"	x	3-1/8"	9
CA-166	7/8"	x	3-1/8"	9
CA-185	1"	x	3-1/8"	9
CA-187	1"	x	3-1/8"	9
CA-39	3/4"	x	3-3/16"	9
CA-73	1"	x	3-3/16"	9
CA-123	1"	x	3-3/16"	9
CA-17	5/8"	x	3-1/4"	9
CA-47	5/8"	x	3-1/4"	10
CA-12	11/16"	x	3-1/4"	10
CA-45	11/16"	x	3-1/4"	10
CA-63	11/16"	x	3-1/4"	10
CA-37	3/4"	x	3-1/4"	10
CA-92	3/4"	x	3-1/4"	10
CA-33	13/16"	x	3-1/4"	10
CA-36	13/16"	x	3-1/4"	10
CA-129	13/16"	x	3-1/4"	11
CA-172	7/8"	x	3-1/4"	11
CA-256	7/8"	x	3-1/4"	11
CA-234	1"	x	3-5/16"	11
CA-225	1-1/16"	x	3-5/16"	11
CA-59	3/8"	x	3-5/16"	11
CA-60	11/16"	x	3-5/16"	11
CA-149	1-1/8"	x	3-5/16"	11
CA-69	9/16"	x	3-3/8"	12
CA-120	3/4"	x	3-3/8"	12
CA-52	13/16"	x	3-3/8"	12
CA-66	13/16"	x	3-3/8"	12
CA-75	13/16"	x	3-3/8"	12

\*SEE next page for more CASING profile sizes.

### ASH-CA-47

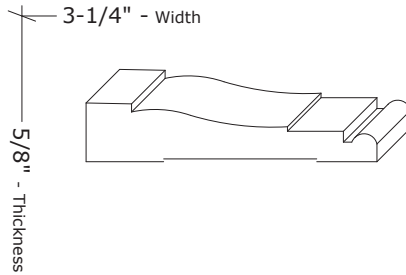

### ASH-CA-45

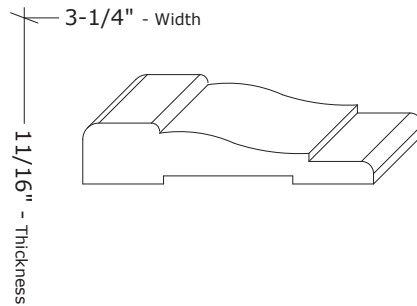

### ASH-CA-37

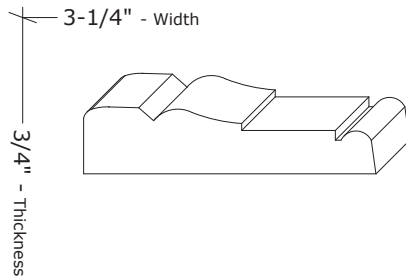

### ASH-CA-33

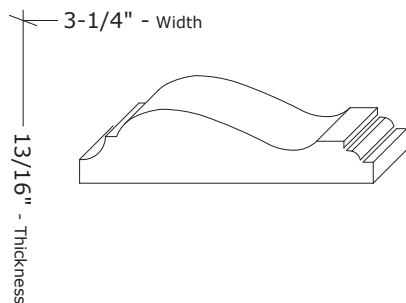

### ASH-CA-12

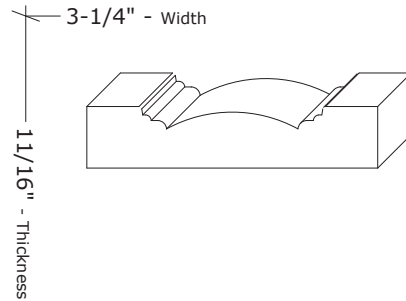

### ASH-CA-63

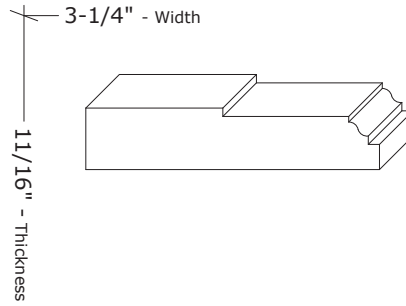

### ASH-CA-92

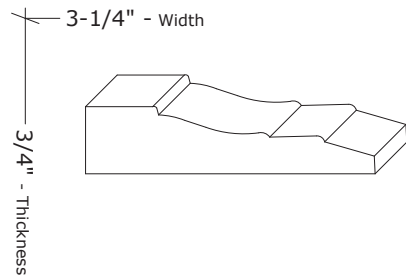

### ASH-CA-36

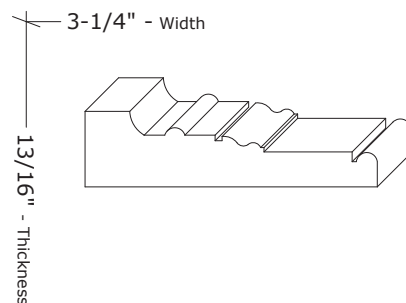

Drawings are NOT actual size. Scaled drawings to size are available upon request.

\*Profile Thicknesses, Heights and/or Widths may be modified.

**Ashland Millwork**  
The finishing touch.™

5 Messner Drive  
Wheeling, IL 60090  
Tel: 1-847-465-8101 Fax: 1-847-465-8102  
Email: sales@ashlandmillwork.com Web: www.ashlandmillwork.com

Job Name: \_\_\_\_\_  
Architect/Builder: \_\_\_\_\_  
Wood Species: \_\_\_\_\_ Qty: \_\_\_\_\_ LF.  
Profile No.: \_\_\_\_\_

**Sec. 6 - 10**