

CASING Profiles

Builders Guide to Custom Moulding & Millwork 1.2

Sec. 6

Profiles at a glance in order by Width.

Profile No.	Th (thickness)	x	W	Page
CA-106	7/8"	x	4-1/2"	24
CA-155	7/8"	x	4-1/2"	24
CA-173	7/8"	x	4-1/2"	24
CA-189	7/8"	x	4-1/2"	24
CA-104	1"	x	4-1/2"	24
CA-137	1"	x	4-1/2"	24
CA-111	1-1/8"	x	4-1/2"	25
CA-32	1-1/4"	x	4-1/2"	25
CA-251	3/4"	x	4-1/2"	25
CA-249	3/4"	x	4-9/16"	25
CA-65	13/16"	x	4-9/16"	25
CA-150	7/8"	x	4-11/16"	25
CA-108	1/2"	x	4-13/16"	25
CA-20	7/8"	x	4-13/16"	25
CA-83	13/16"	x	4-7/8"	26
CA-253	13/16"	x	5"	26
CA-240	1-3/16"	x	5-3/8"	26
CA-125	13/16"	x	5-3/8"	26
CA-255	7/8"	x	5-3/8"	26
CA-261	13/16"	x	5-3/8"	26
CA-226	13/16"	x	5-1/2"	26
CA-238	1-3/4"	x	8-1/8"	26

*SEE next page for more CASING profile sizes.

ASH-CA-69

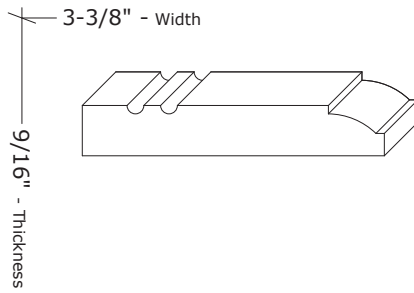

ASH-CA-120

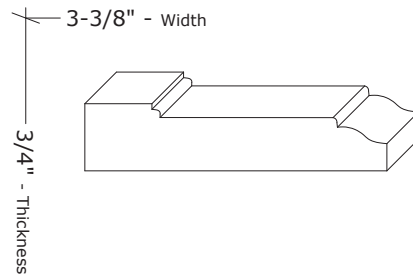

ASH-CA-52

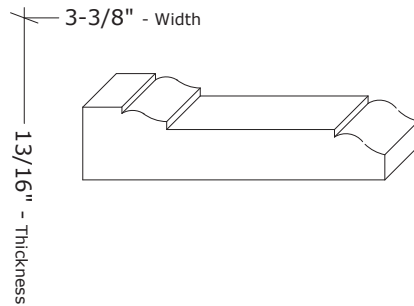

ASH-CA-66

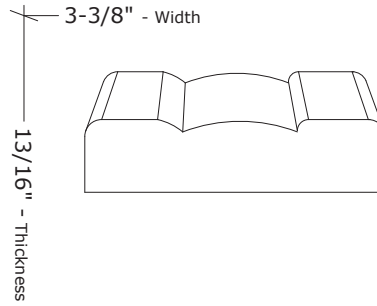

ASH-CA-75

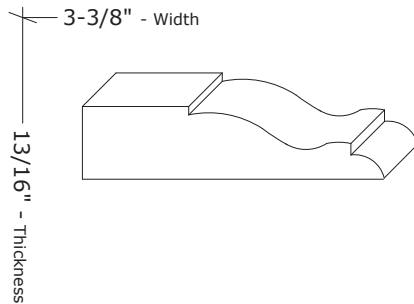

ASH-CA-227

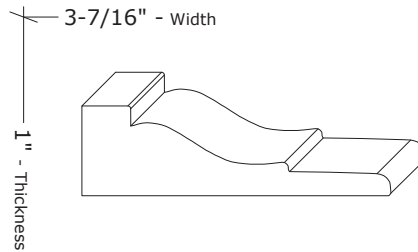

ASH-CA-40

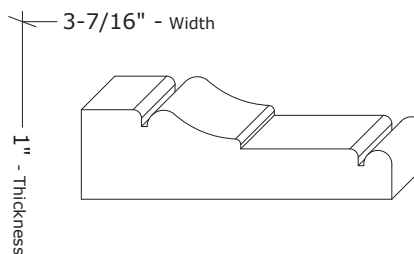

ASH-CA-264

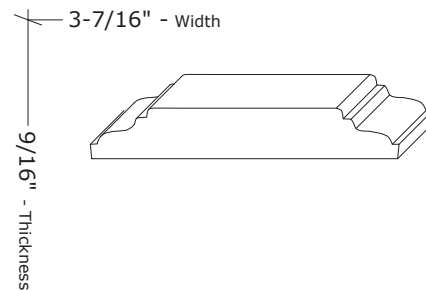

*Profile Thicknesses, Heights and/or Widths may be modified.

Ashland Millwork
The finishing touch.™

5 Messner Drive
Wheeling, IL 60090
Tel: 1-847-465-8101 Fax: 1-847-465-8102
Email: sales@ashlandmillwork.com Web: www.ashlandmillwork.com

Job Name: _____
Architect/Builder: _____
Wood Species: _____ Qty: _____ LF.
Profile No.: _____

Sec. 6 - 12

Drawings are NOT actual size.
Scaled drawings to size are available upon request.