

CASING Profiles

Builders Guide to Custom Moulding & Millwork 1.2

Sec. 6

Profiles at a glance in order by Width.

Profile No.	Th (thickness)	x	W	Page
CA-227	1"	x	3-7/16"	12
CA-40	1"	x	3-7/16"	12
CA-264	9/16"	x	3-7/16"	12
CA-247	3/4"	x	3-1/2"	13
CA-246	1-1/4"	x	3-1/2"	13
CA-101	1/2"	x	3-1/2"	13
CA-127	1/2"	x	3-1/2"	13
CA-85	5/8"	x	3-1/2"	13
CA-16	3/4"	x	3-1/2"	13
CA-18	3/4"	x	3-1/2"	13
CA-42	3/4"	x	3-1/2"	13
CA-61	3/4"	x	3-1/2"	14
CA-80	3/4"	x	3-1/2"	14
CA-128	3/4"	x	3-1/2"	14
CA-168	3/4"	x	3-1/2"	14
CA-27	13/16"	x	3-1/2"	14
CA-29	13/16"	x	3-1/2"	14
CA-103	7/8"	x	3-1/2"	14
CA-117	7/8"	x	3-1/2"	14
CA-119	7/8"	x	3-1/2"	15
CA-181	7/8"	x	3-1/2"	15
CA-105	1"	x	3-1/2"	15
CA-142	1"	x	3-1/2"	15
CA-194	1"	x	3-1/2"	15
CA-239	3/4"	x	3-1/2"	15
CA-244	13/16"	x	3-1/2"	15
CA-184	5/8"	x	3-9/16"	15
CA-97	3/4"	x	3-9/16"	16
CA-144	3/4"	x	3-9/16"	16
CA-167	3/4"	x	3-9/16"	16
CA-13	13/16"	x	3-9/16"	16
CA-257	3/4"	x	3-9/16"	16
CA-158	5/8"	x	3-5/8"	16
CA-5	11/16"	x	3-5/8"	16
CA-6	7/8"	x	3-5/8"	16
CA-91	7/8"	x	3-5/8"	17
CA-7	5/8"	x	3-11/16"	17
CA-86	3/4"	x	3-11/16"	17
CA-87	3/4"	x	3-11/16"	17
CA-26	1/2"	x	3-3/4"	17
CA-77	11/16"	x	3-3/4"	17
CA-54	3/4"	x	3-3/4"	17
CA-64	3/4"	x	3-3/4"	17
CA-67	3/4"	x	3-3/4"	18
CA-107	3/4"	x	3-3/4"	18
CA-122	3/4"	x	3-3/4"	18
CA-140	3/4"	x	3-3/4"	18
CA-241	7/8"	x	3-3/4"	18
CA-164	3/4"	x	3-3/4"	18
CA-84	13/16"	x	3-3/4"	18
CA-102	7/8"	x	3-3/4"	18
CA-176	1-1/4"	x	3-3/4"	19
CA-254	3/4"	x	3-3/4"	19
CA-191	3/4"	x	3-13/16"	19
CA-4	3/4"	x	3-7/8"	19
CA-132	3/4"	x	3-7/8"	19
CA-134	3/4"	x	3-7/8"	19
CA-68	13/16"	x	3-7/8"	19
CA-96	7/8"	x	3-7/8"	19
CA-126	7/8"	x	3-7/8"	20
CA-56	1-3/16"	x	3-7/8"	20
CA-124	1-3/16"	x	3-7/8"	20
CA-9	3/4"	x	3-15/16"	20
CA-44	7/8"	x	3-15/16"	20
CA-25	1/2"	x	4"	20
CA-135	5/8"	x	4"	20
CA-70	3/4"	x	4"	20
CA-110	3/4"	x	4"	21
CA-186	3/4"	x	4"	21
CA-8	13/16"	x	4"	21
CA-112	7/8"	x	4"	21
CA-38	1"	x	4"	21
CA-116	1-1/8"	x	4"	21
CA-161	1-1/4"	x	4"	21
CA-10	1-5/16"	x	4"	21
CA-177	1/2"	x	4-1/8"	22
CA-175	3/4"	x	4-1/8"	22
CA-35	1"	x	4-1/8"	22
CA-41	15/16"	x	4-3/16"	22
CA-2	3/4"	x	4-1/4"	22
CA-19	3/4"	x	4-1/4"	22
CA-143	3/4"	x	4-1/4"	22
CA-3	13/16"	x	4-1/4"	22
CA-159	1-1/16"	x	4-1/4"	23
CA-180	1-1/16"	x	4-1/4"	23
CA-23	3/4"	x	4-3/8"	23
CA-31	3/4"	x	4-7/16"	23
CA-192	13/16"	x	4-7/16"	23
CA-260	3/4"	x	4-1/2"	23
CA-11	11/16"	x	4-1/2"	23
CA-147	3/4"	x	4-1/2"	23
CA-188	3/4"	x	4-1/2"	24
CA-1	13/16"	x	4-1/2"	24

ASH-CA-153

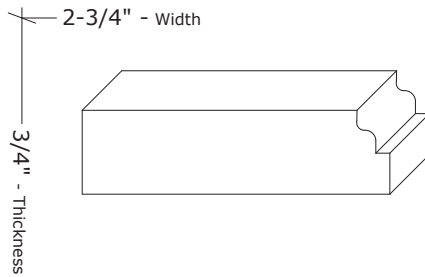

ASH-CA-99

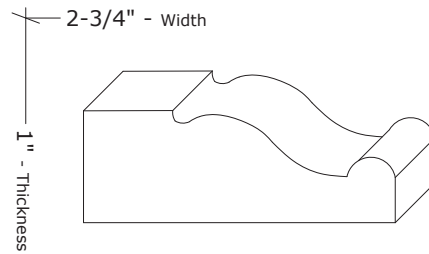

ASH-CA-88

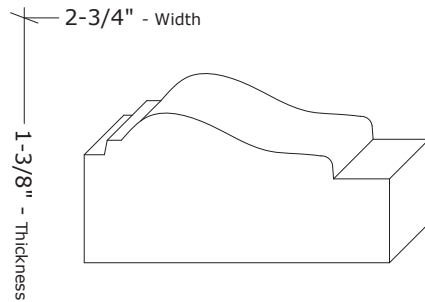

ASH-CA-14

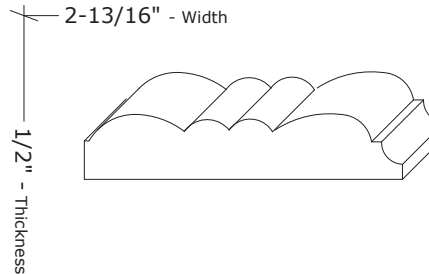

ASH-CA-81

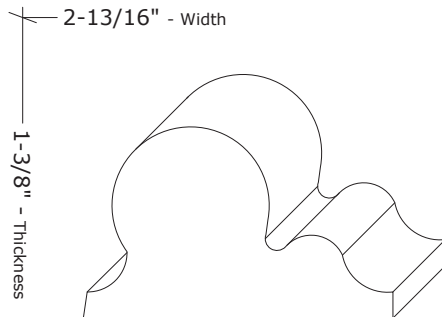

ASH-CA-250

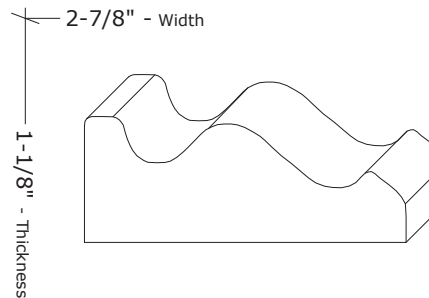

ASH-CA-109

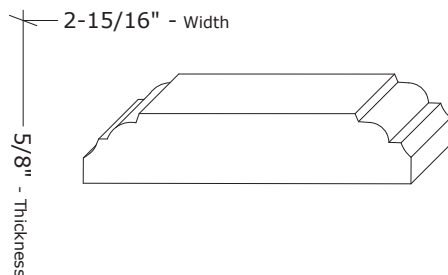

ASH-CA-114

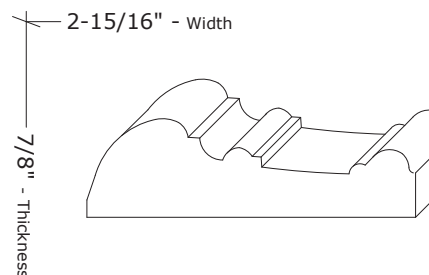

*SEE next page for more CASING profile sizes.

Drawings are NOT actual size. Scaled drawings to size are available upon request.

Ashland Millwork
The finishing touch.™

5 Messner Drive
Wheeling, IL 60090
Tel: 1-847-465-8101 Fax: 1-847-465-8102
Email: sales@ashlandmillwork.com Web: www.ashlandmillwork.com

*Profile Thicknesses, Heights and/or Widths may be modified.

Job Name: _____
Architect/Builder: _____
Wood Species: _____ Qty: _____ LF.
Profile No.: _____

Sec. 6 - 5