

CHAIR RAIL Profiles

Builders Guide to Custom Moulding & Millwork 1.2

Sec. 7

Profiles at a glance in order by height.

Profile No.	Th (thickness)	x	H	Page
CH-18	7/8"	x	1-5/8"	1
CH-24	1-1/4"	x	1-3/4"	1
CH-1	1-1/2"	x	1-13/16"	1
CH-22	1"	x	2-1/16"	1
CH-21	1-1/16"	x	2-1/8"	1
CH-13	1/2"	x	2-3/16"	1
CH-17	3/4"	x	2-1/4"	1
CH-25	1"	x	2-1/4"	1
CH-29	1-5/8"	x	2-1/2"	1
CH-11	3/4"	x	2-1/2"	2
CH-14	1"	x	2-1/2"	2
CH-16	3/4"	x	2-9/16"	2
CH-12	5/8"	x	2-5/8"	2
CH-27	1-1/2"	x	2-5/8"	2
CH-4	1-1/16"	x	2-3/4"	2
CH-26	11/16"	x	2-3/4"	2
CH-3	1-15/16"	x	2-3/4"	2
CH-5	3/4"	x	2-13/16"	3
CH-9	15/16"	x	3"	3
CH-10	15/16"	x	3"	3
CH-20	13/16"	x	3-3/16"	3
CH-2	1-3/4"	x	3-3/16"	3
CH-8	15/16"	x	3-1/4"	3
CH-6	11/16"	x	3-3/8"	3
CH-19	3/4"	x	3-7/16"	3
CH-7	3/4"	x	3-1/2"	3
CH-23	1"	x	3-1/2"	4
CH-28	3/4"	x	4"	4

Request your own custom profile.

Call today!
1-847-465-8101

ASH-CH-11

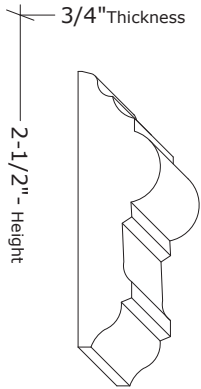

ASH-CH-14

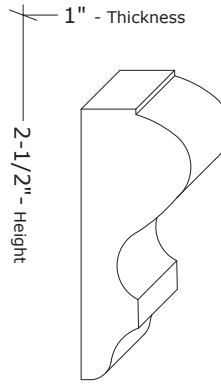

ASH-CH-16

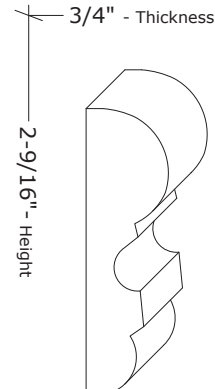

ASH-CH-12

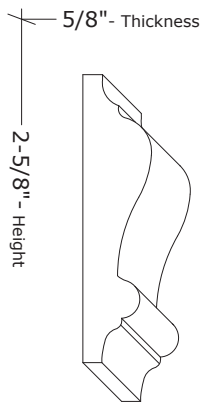

ASH-CH-27

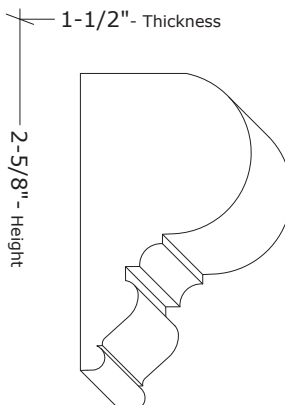

ASH-CH-4

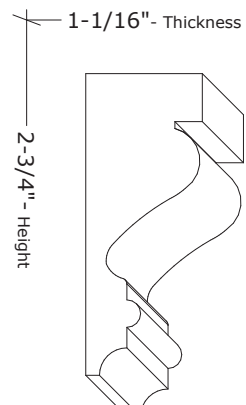

ASH-CH-26

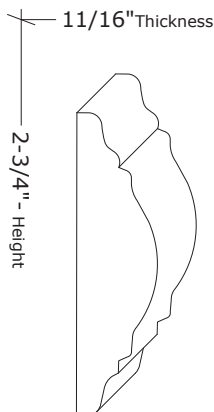

ASH-CH-3

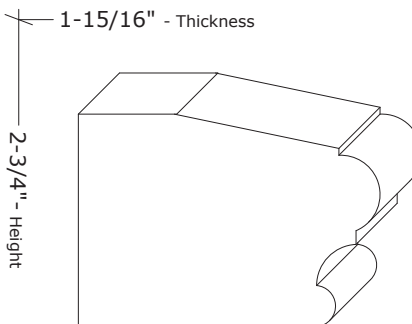

Drawings are NOT actual size.
Scaled drawings to size are available upon request.

Ashland Millwork
The finishing touch.™

5 Messner Drive
Wheeling, IL 60090
Tel: 1-847-465-8101 Fax: 1-847-465-8102
Email: sales@ashlandmillwork.com Web: www.ashlandmillwork.com

*Profile Thicknesses, Heights and/or Widths may be modified.

Job Name: _____
Architect/Builder: _____
Wood Species: _____ Qty: _____ LF.
Profile No.: _____

Sec. 7 - 2